

MAHLE

Industry

Low Pressure Filter/Suction Filter

Pi 1941

Nominal pressure 10/25 bar (140/360 psi), up to nominal size 63

1. Features

High performance filters for modern hydraulic systems

- Provided for pipe installation
- Modular system
- Compact design
- Minimal pressure drop through optimal flow design
- Visual maintenance indicator
- Threaded connections
- Quality filters, easy to service
- Equipped with highly efficient glass fibre Sm-x and Mic filter elements
- Beta rated elements according to ISO 16889 multipass test
- Elements with high differential pressure stability and dirt holding capacity
- Worldwide distribution



2. Flow rate/pressure drop curve complete filter

■ 190 mm²/s
■ 33 mm²/s

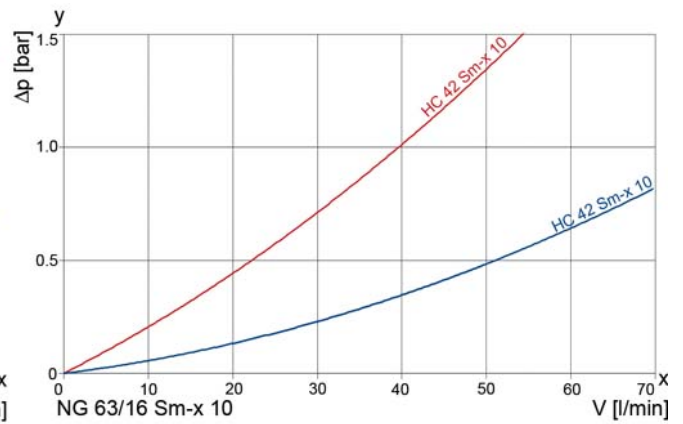
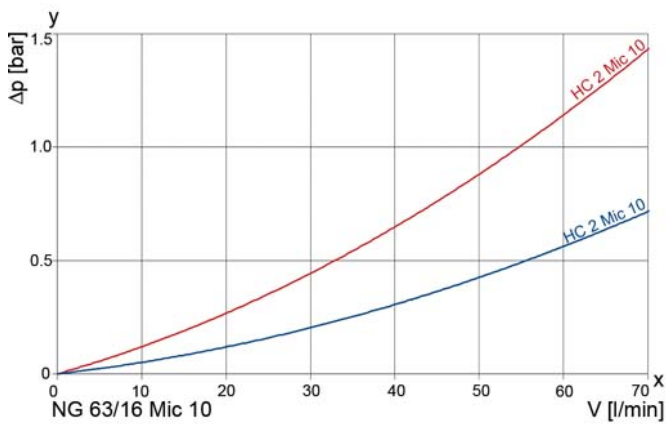
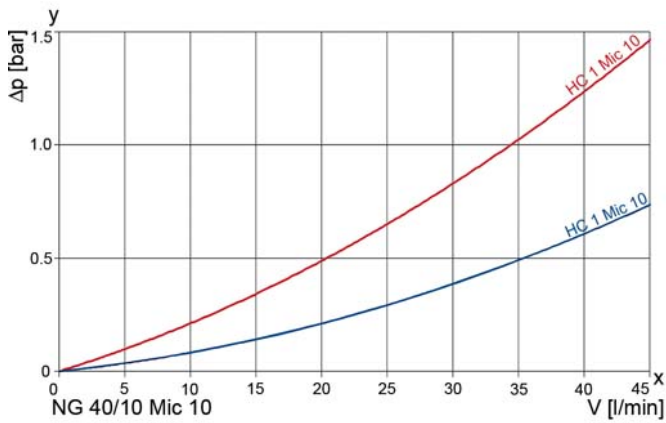
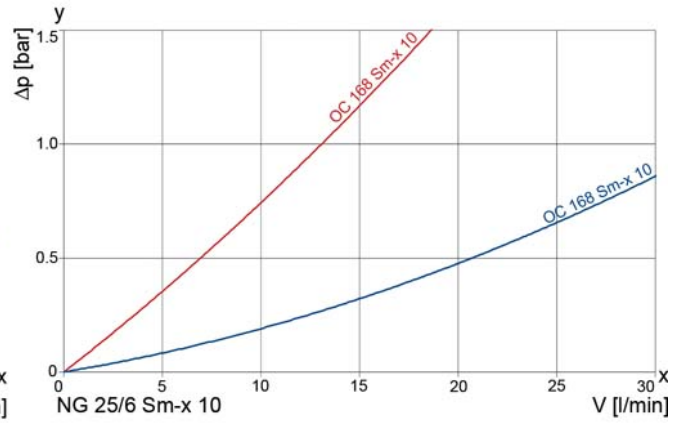
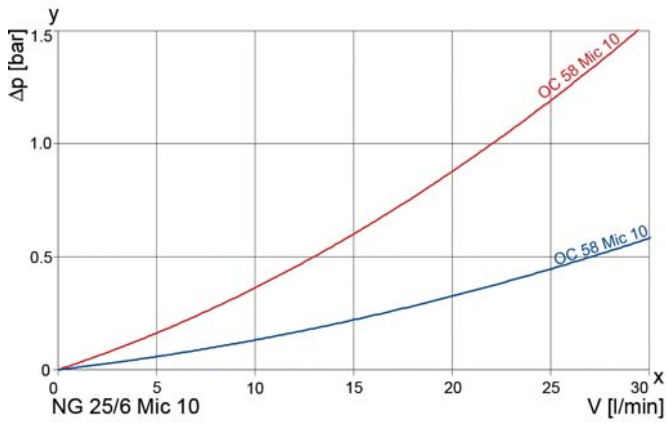
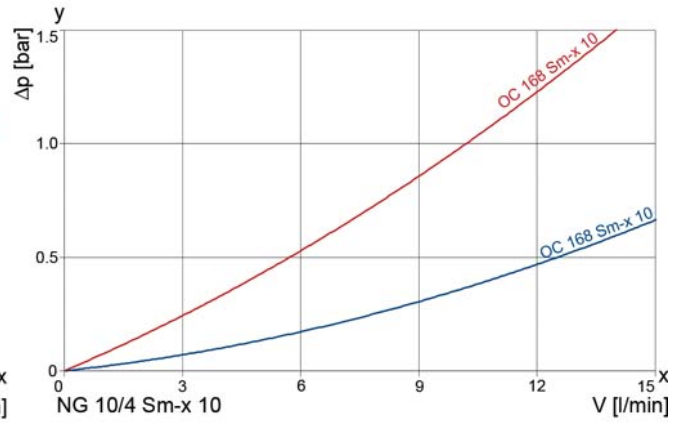
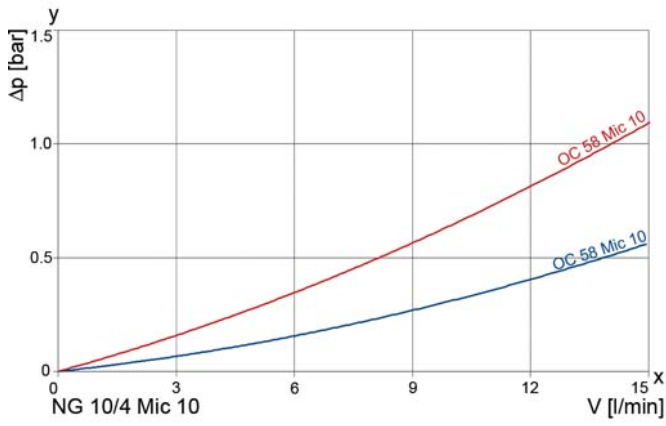

y = differential pressure Δp [bar]
 x = flow rate V [l/min]

3. Separation grade characteristics

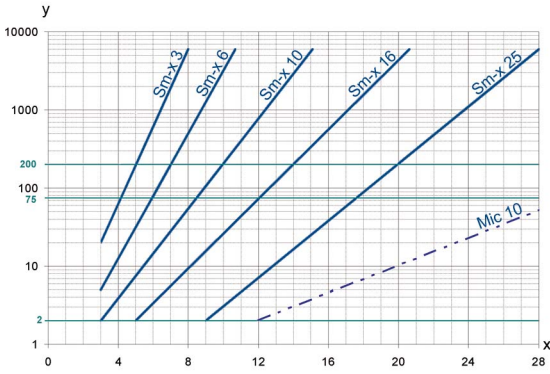

y = beta-value
x = particle size μm

determined by multipass tests (ISO 16889)
calibration according to ISO 11171 (NIST)

4. Filter performance data

tested according to ISO 16889 (multipass test)

Sm-x elements with
max. Δp 5 bar

Sm-x 10 $\beta_{10(C)} \geq 75$

values guaranteed up to
5 bar differential pressure

5. Quality assurance

MAHLE filters and filter elements are produced according to the following international standards:

Norm	Designation
DIN ISO 2941	Hydraulic filter elements: Verification of burst resistance
DIN ISO 2942	Hydraulic filter elements: Determination of fabrication integrity
DIN ISO 2943	Hydraulic filter elements: Verification of material compatibility with hydraulic fluids
DIN ISO 3723	Hydraulic filter elements: Method for testing end-cap load
DIN ISO 3724	Hydraulic filter elements: Verification of flow fatigue characteristics
ISO 3 968.2	Hydraulic filter elements: Evaluation of pressure drop versus flow
ISO 16889	Hydraulic filter elements: Testing of filter performance

6. Symbols

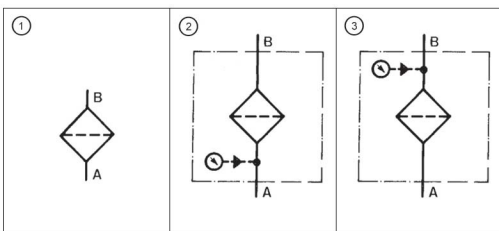

7. Order numbers

Example for ordering filters:

1. Housing design

V= 63 l/min, pressure gauge + spin-on cartridge Mic 10

Type Pi 1941/10/G¾/DM + HC 2

Order number 77807811 + 72013241

7.1 Housing design/order number for pressure-side installation

Nominal flow rate NG [l/min]	Order number	Type	①	②
			no options	with pressure gauge
10	77664360	Pi 1941/10/G¼		
	77812225	Pi 1941/10/G¼/DM		
25	77664386	Pi 1941/10/G3/8		
	77815509	Pi 1941/10/G3/8/DM		
40	77664394	Pi 1941/10/G½		
	77664402	Pi 1941/10/G½/DM		
63	77664378	Pi 1941/10/G¾		
	77807811	Pi 1941/10/G¾/DM		

7.2 Spin-on cartridges

Nominal flow rate NG [l/min] press-/suct. side	Order number	Type	Filter material	max. Δ p [bar]	Filter surface [cm²]
10/4	77785983	OC 58	Mic 10	5	1775
	77500184	OC 168	Sm-x 10		1309
25/6	77785983	OC 58	Mic 10	5	1775
	77500184	OC 168	Sm-x 10		1309
40/10	77640899	HC 1	Mic 10	5	3000
63/16	72013241	HC 2	Mic 10	5	5440
	77501372	HC 42	Sm-x 10		3360

7.3 Housing design/order numbers for suction-side installation

Nominal flow rate NG [l/min]	Order number	Type	①	③
			no options	with vacuum gauge
4	77664360	Pi 1941/10/G¼		
	77894033	Pi 1941/10/G¼/UM		
6	77664386	Pi 1941/10/G3/8		
	77894041	Pi 1941/10/G3/8/UM		
10	77664394	Pi 1941/10/G½		
	77894058	Pi 1941/10/G½/UM		
16	77664378	Pi 1941/10/G¾		
	77658966	Pi 1941/10/G¾/UM		

8. Technical specifications

Design:	line mounting filter
Nominal pressure*:	10 bar (140 psi)
Test pressure:	13 bar (180 psi)
Temperature range:	-10 °C to +120 °C (other temperature ranges on request)
Filter head material:	GDAL
Spin-on cartridge material:	St
Sealing material:	NBR
Installation position:	preferably vertical
Indicating range pressure manometer:	0 to 10 bar
Indicating range vacuum gauge:	-1 to 0 bar

*For the combination of the housing designs as per 7.1 with medium-pressure spin-on cartridges at 25 bar pressure refer to data sheet "spin-on cartridges" for dimensions and specifications.

We draw attention to the fact that all values indicated are average values and do not always occur in specific cases of application. Our products are continually being further developed. Values, dimensions and weights can change as a result of this. Our specialized department will be pleased to offer you advice.

We recommend you to contact us concerning applications of our filters in areas governed by the EU Directive 94/9 EC (ATEX 95). The standard version can be used for liquids based on mineral oil (corresponding to the fluids in Group 2 of Directive 97/23 EC Article 9). If you consider to use other fluids please contact us for additional support.

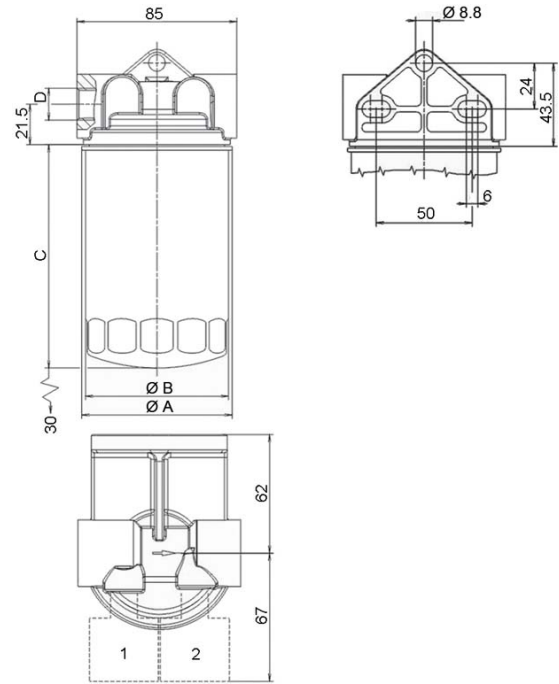

1 = pressure gauge

2 = vacuum gauge

Subject to technical alteration without prior notice.

9. Dimensions

All dimensions except "D" in mm.

Type	Ø A	Ø B	C	D	Weight [kg] Execution Mic*	Weight [kg] Execution Sm-x*
Pi 1941/10/G 1/4	80	76	120	G 1/4	0.67	0.82
Pi 1941/10/G 3/8	80	76	120	G 3/8	0.67	0.82
Pi 1941/10/G 1/2	95	93	141	G 1/2	0.82	1.02
Pi 1941/10/G 3/4	95	93	210	G 3/4	1.02	1.02

*Design with gauge + 0.1 kg

10. Installation, operating and maintenance instructions

10.1 Filter installation

When installing the filter make sure that sufficient space is available to remove the spin-on cartridge.

Preferably the filter should be installed with the spin-on cartridge pointing downwards.

10.2 When should the spin-on cartridge be replaced?

1. Filter equipped with the vacuum gauge for suction-side installation: During cold start the vacuum gauge may for a short period indicate > 0.2 bar. With increasing operating temperature the indicator needle must drop clearly below the 0.2 bar mark. Should this not be the case, the spin-on cartridge must be replaced after the end of the shift.
2. Filters without maintenance indicator: The spin-on cartridge should be replaced after the trial run or flushing of the system. Afterwards follow instructions of the manufacturer.
3. Please always ensure that you have original MAHLE spare cartridges in stock.

10.3 Change of spin-on cartridge

1. Stop system and relieve filter from pressure.
2. Unscrew the spin-on cartridge with the aid of a belt spanner by turning same to the left.
3. Make sure that the order number on the new spin-on cartridge corresponds to the order number of the name-plate.
4. The seal of the spin-on cartridge should be lightly oiled.
5. Screw cartridge on in accordance with the printed-on instructions.

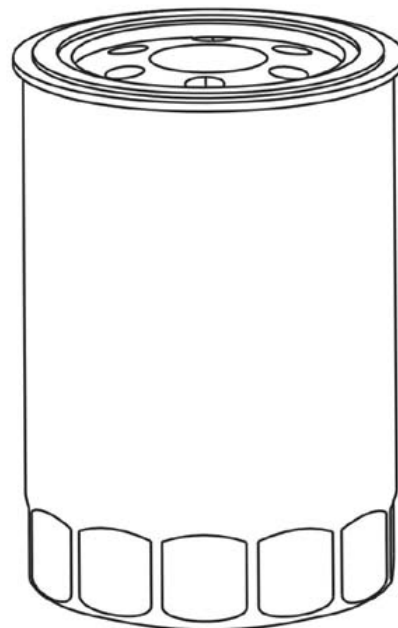
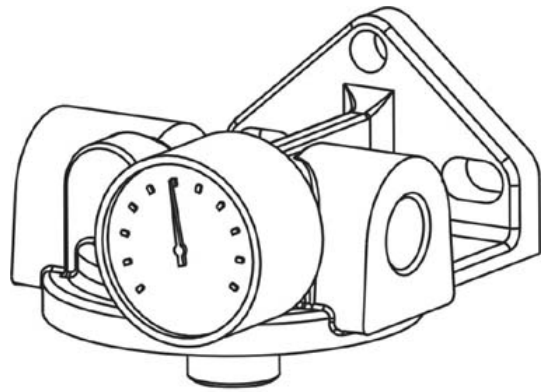

11. Spare parts list

Position	Type	Order number
①	Pressure gauge (not shown)	77870611
②	Vacuum gauge	77617558

MAHLE Industriefiltration GmbH
Schleifbachweg 45
74613 Öhringen
Phone +49 7941 67-0
Fax +49 7941 67-23429
industriefiltration@mahle.com
www.mahle-industriefiltration.com
78357337.02/2012